

BioBox L
 Sk420 + BioBox I
 Sk600 + BioBox I
 Sk1200 + 2xBioBox I

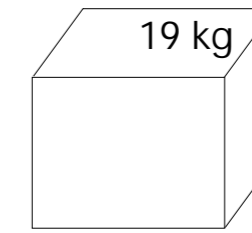

600x600x850

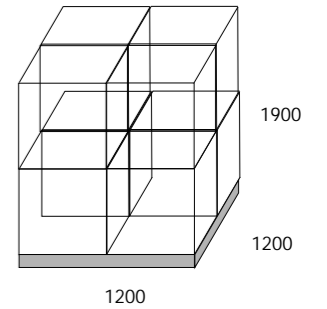

1 pc size 600x600x850 mm
 8 pcs size 1200x1200x1900 (with pallet)



q-max 400 l / 24 h - 50 l / h

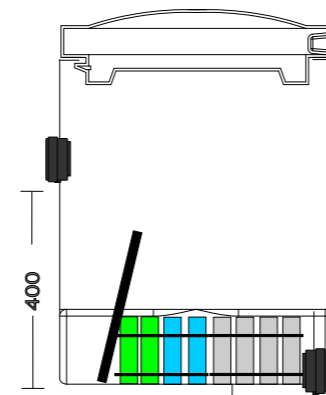

2 m² + 12 m²

Malli, varustetaso, lisävarusteet:

Malli	Kapasiteetti l / 24 h	SK 420	SK600	SK1200 SAV	BM	Pakor
Bio-Box L	400	+	+	+	+	+

Modell, utrustningsnivå, tilläggsutrustning::

Modell	Kapasitet l / 24 h	SK 420	SK600	SK1200 SAV	BM	Pakor
Bio-Box L	400	+	+	+	+	+

Model, equipment level, auxiliary equipment:

Model	Capacity l / 24 h	SK 420	SK600	SK1200 SAV	BM	Pakor
Bio-Box L	400	+	+	+	+	+

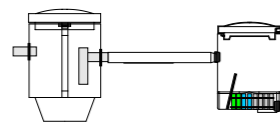

q-max 400 l / 24 h - 80 l / h

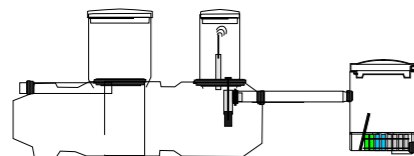

q-max 400 l / 24 h - 100 l / h

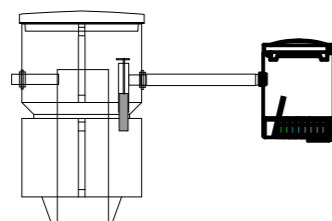

q-max 400 l / 24 h - 100 l / h

		Scale:
	BioBox L	2014
 www.raita.com		

BioBox L

q-max 400 l/ 24 h - 50 l/ h

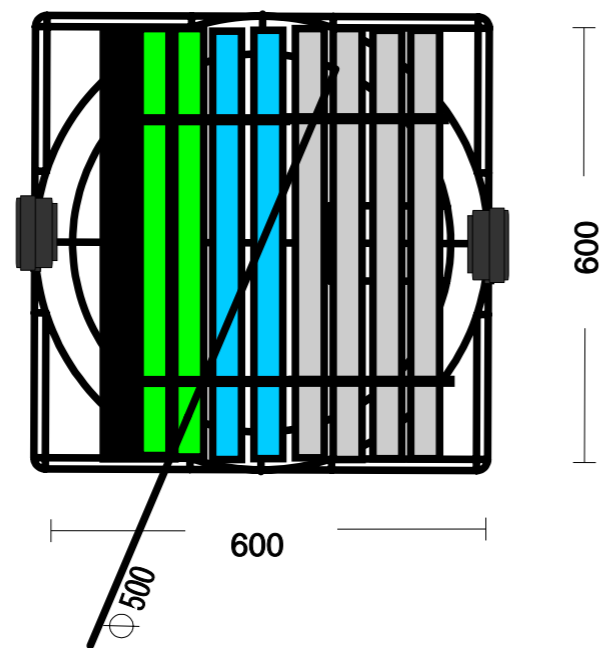
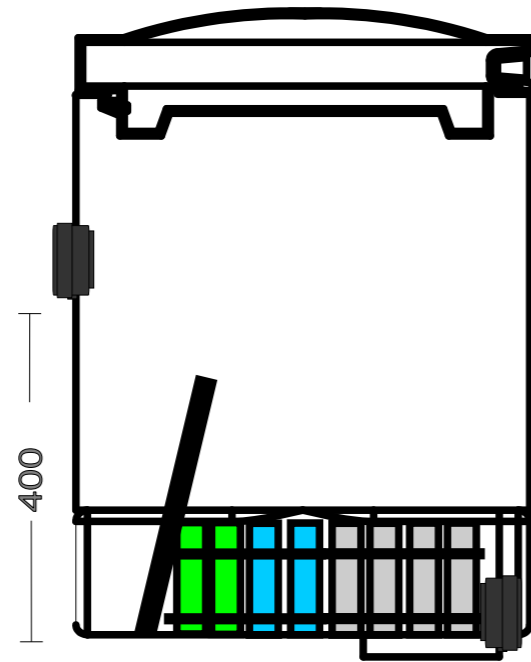

Malli, varustetaso, lisävarusteet:

Malli	Kapasiteetti l/ 24 h
Bio-Box L	400

Modell, utrustningsnivå, tilläggsutrustning::

Modell	Kapasitet l/ 24 h
Bio-Box L	400

Model, equipment level, auxiliary equipment:

Model	Capacity l/ 24 h
Bio-Box L	400

		Scale:
	BioBox L	2014
		
www.raita.com		

BioBox L +pakor

q-max 400 l/ 24 h - 50 l/ h

713 + 500

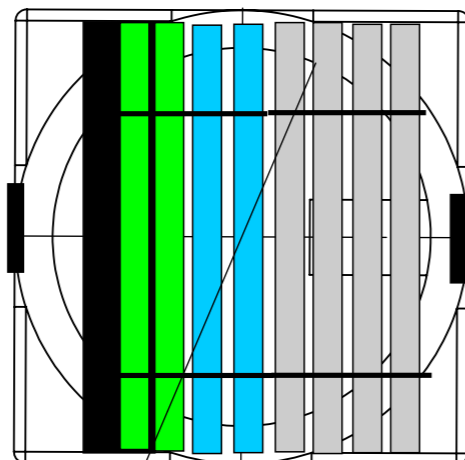
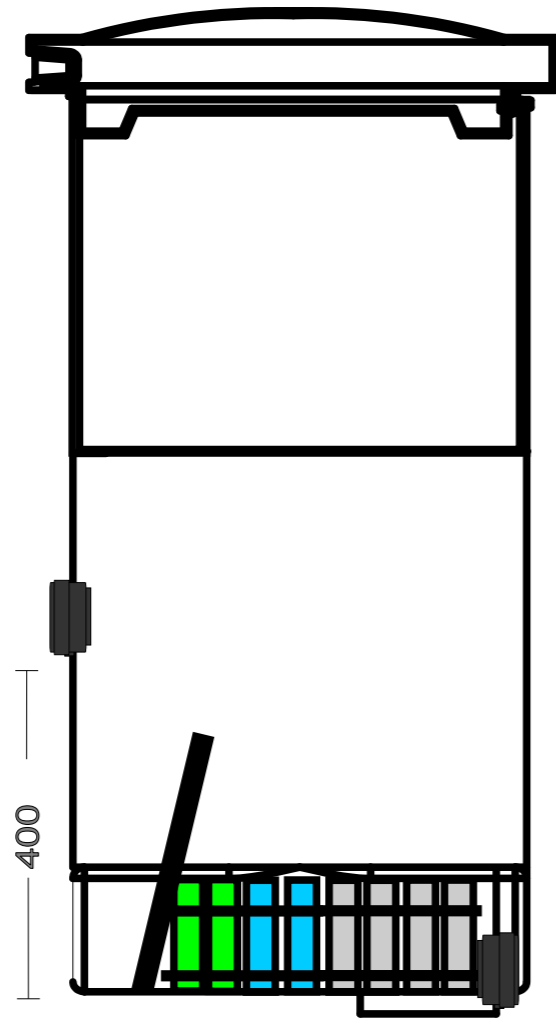

600

600

Malli, varustetaso, lisävarusteet:

Malli	Kapasiteetti l/ 24 h	Pakor
Bio-Box L	400	+

Modell, utrustningsnivå, tilläggsutrustning::

Modell	Kapasitet l/ 24 h	Pakor
Bio-Box L	400	+

Model, equipment level, auxiliary equipment:

Model	Capacity l/ 24 h	Pakor
Bio-Box L	400	+

		Scale:
	BioBox L	2014
		
www.raita.com		

Sk100 + BioBox L

q-max 400 l/ 24 h - 80 l/ h

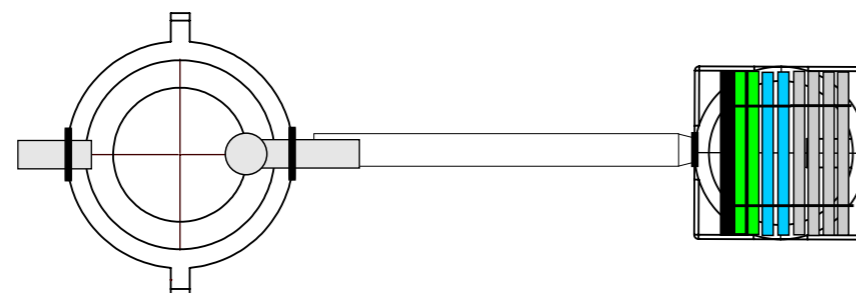
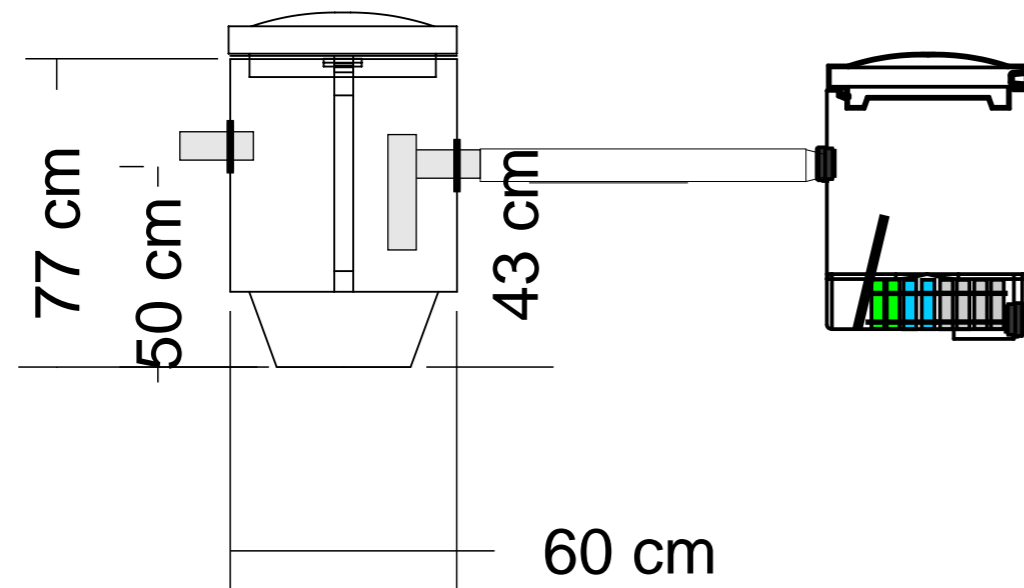

Malli, varustetaso, lisävarusteet:

Malli	Kapasiteetti l/ 24 h	SK 100	Pakor
Bio-Box L	400	+	+

Modell, utrustningsnivå, tilläggsutrustning::

Modell	Kapasitet l/ 24 h	SK 100	Pakor
Bio-Box L	400	+	+

Model, equipment level, auxiliary equipment:

Model	Capacity l/ 24 h	SK 100	Pakor
Bio-Box L	400	+	+

		Scale:
	BioBox L	2014
		
www.raita.com		

Sk420 + BioBox L (+pakor)

q-max 400 l / 24 h - 100 l / h

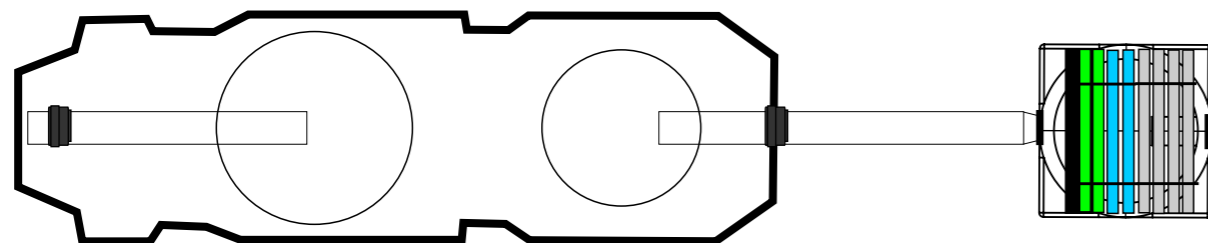
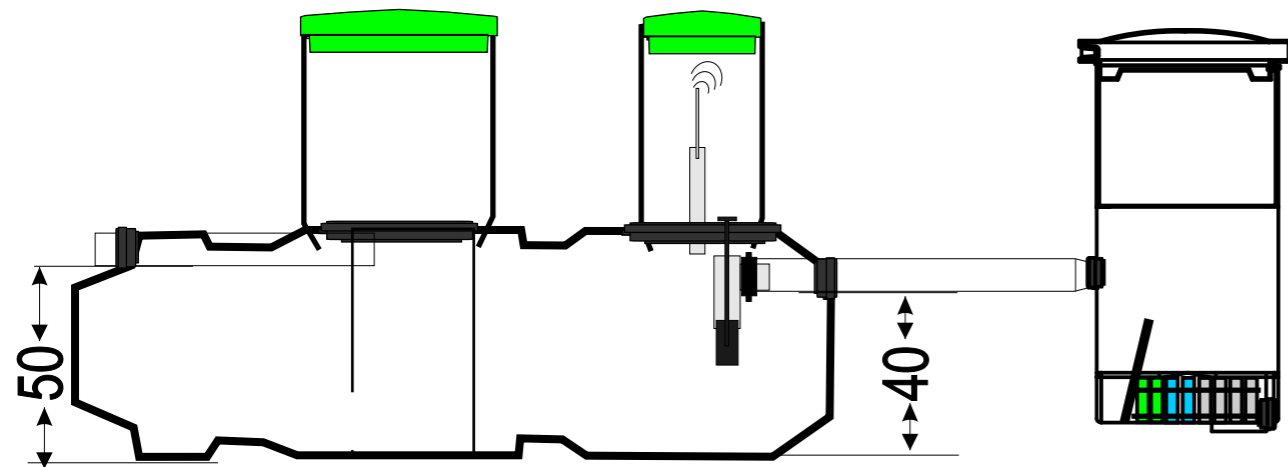
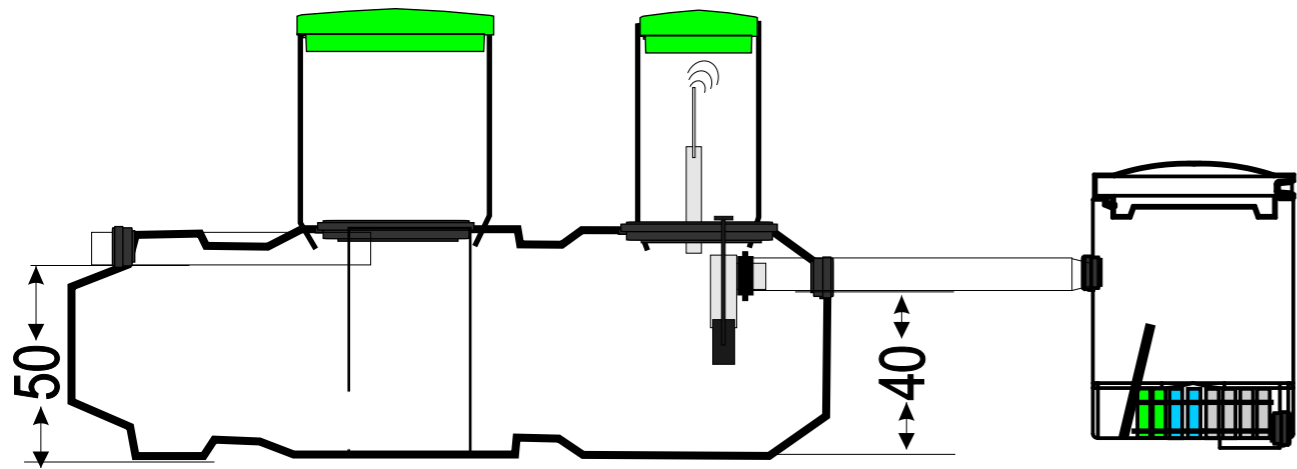

Malli, varustetaso, lisävarusteet:

Malli	Kapasiteetti l / 24 h	SK 420	Pakor
Bio-Box L	400	+	+

Modell, utrustningsnivå, tilläggsutrustning::

Modell	Kapasitet l / 24 h	SK 420	Pakor
Bio-Box L	400	+	+

Model, equipment level, auxiliary equipment:

Model	Capacity l / 24 h	SK 420	Pakor
Bio-Box L	400	+	+

		Scale:
	BioBox L	2014
		
www.raita.com		

Sk600 + BioBox L

q-max 400 l / 24 h - 100 l / h

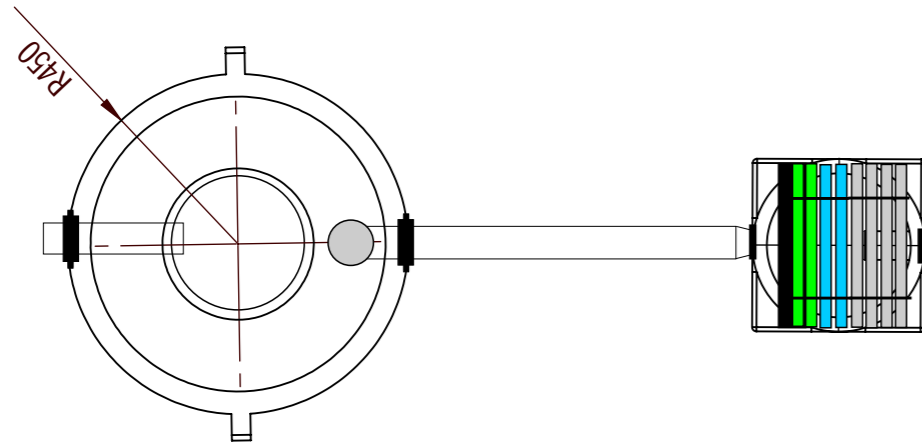
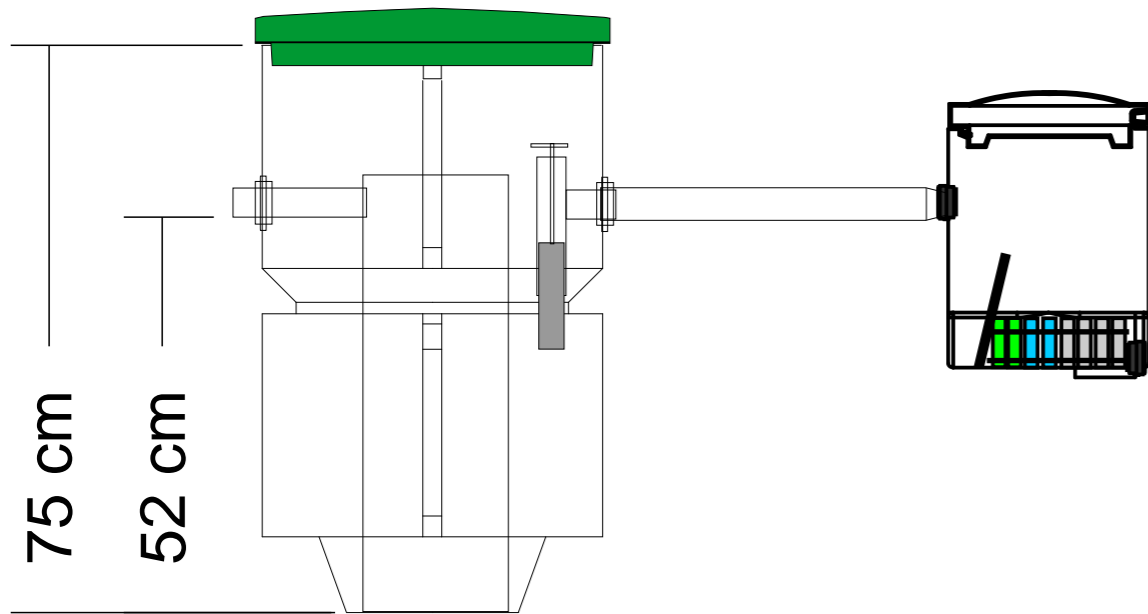

Malli, varustetaso, lisävarusteet:

Malli	Kapasiteetti l / 24 h	SK600	Pakor
Bio-Box L	400	+	+

Modell, utrustningsnivå, tilläggsutrustning::

Modell	Kapasitet l / 24 h	SK600	Pakor
Bio-Box L	400	+	+

Model, equipment level, auxiliary equipment:

Model	Capacity l / 24 h	SK600	Pakor
Bio-Box L	400	+	+

		Scale:
	BioBox L	2014
 www.raita.com		

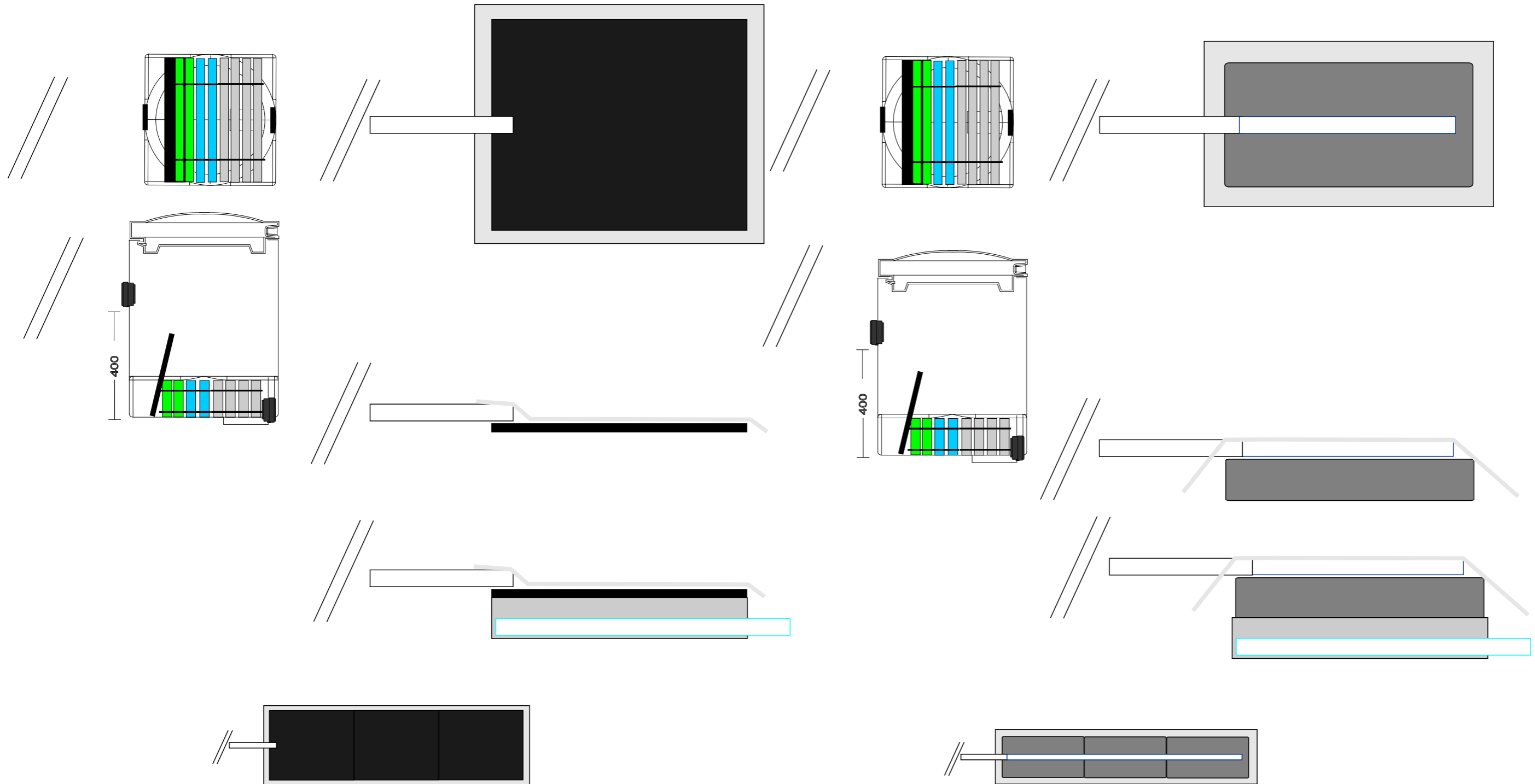

Malli, varustetaso, lisävarusteet:

Malli	Kapasiteetti l/ 24 h	SK 420	SK600	SK1200 SAV	BM	Pakor
Bio-Box L	400	+	+	+	+	+

Modell, utrustningsnivå, tilläggsutrustning::

Modell	Kapasitet l/ 24h	SK 420	SK600	SK1200 SAV	BM	Pakor
Bio-Box L	400	+	+	+	+	+

Model, equipment level, auxiliary equipment:

Model	Capacity l/ 24 h	SK 420	SK600	SK1200 SAV	BM	Pakor
Bio-Box L	400	+	+	+	+	+

		Scale:
	BioBox L	
		2014
		
www.raita.com		